

Awning Tents

GENERAL INFORMATION	
Awning Tents - Fit Guide	96
Awning Tents - Overview Van & Compact Van	98
Awning Tents - User Manual	98
Awning Tents - General Instructions	98
Awning Tents - Maintenance	99
Awning Tents - Important Safety Instructions	99
AWNING TENTS	
Thule Panorama	100
Thule Residence G3	103
Thule Veduta	106
Thule QuickFit	108

Awning Tents - Fit Guide

	Thule Panorama	Thule Residence G3	Thule Veduta	Thule QuickFit
Stay	Long stay	Long stay	Long stay	Short stay
INSTALLATION				
Motorhome	•	•		•
Caravan	•	• + Eriba Touring	•	•
Van	• Ducato H2	• Ducato H2		• Ducato H2
Compact Van		•		
FITS				
Awnings	5200 • 8000 9200 • 6300 5003 • 5002 5500 • 6200 6002	5200 • 8000 4900 • 5102 9200 • 6300 5003 • 5002 5500 • 6200 6900 • 6002 4200	6300 • 6200	5200 • 8000 4900 • 9200 6300 • 1200 5003 • 5002 5500 • 6200 6900 • 6002 4200 + other brands
Awning lengths	3.00 m - 6.00 m	3.00 m - 6.00 m	4.00 m - 5.00 m	3.00 m - 6.00 m
Mounting height	2.30 m - 2.74 m	2.15 m - 3.10 m	2.45 - 2.59 m	2.25 m - 2.84 m
Vehicle wall	Straight wall Curved wall Ducato	Straight wall Curved wall Ducato & Eriba Touring	Straight wall	Straight wall Curved wall Ducato
SPECIFICATIONS				
Maximum tent length	6.00 m	6.00 m	5.00 m	3.60 m
Fabric	AIRTEX® Fabric	PVC Fabric	AIRTEX® Fabric	RIPSTOP Fabric
Curtains	Optional	Optional	Optional	Included
Windslip	Included	Included (with front panel)	Included	Included
Wheelcover	- Included with Ducato H2 tent model - Optional for other tent models	- Included with fronts of Ducato tent models - Included with Eriba Touring tent model - Optional for other Residence G3 sides or fronts	Optional	Included
Storage bag	2 Luxury bags	2 Luxury bags (included with side panels)	2 Luxury bags	Sport bag

Awning Tents - Overview Van & Compact Van

		 Ducato Jumper Boxer Movano >2022 H2			 Ducato Jumper Boxer Movano >2022 H2 with lift roof				 Ford Transit H3 New			 Compact Van		
		L2 (5400)	L3 (6000)	L4 (6400)	L2 (5400)	L3 (6000)		L4 (6400)	L2 (5500)	L3 (6000)	L4 (6700)	VW T5/T6 MB Vito	VW Transporter California	
Awnings	Awnings	TO 6300			TO 5200				TO 5200			T 4200	TO 5102	
	Length	3.25 m	3.75 m	4.00 m	3.00 m	3.15 m	3.50 m	3.75 m	4.00 m	3.00 m	3.50 m	4.00 m	2.60	2.60
	Adapter	301649	301650	301650	308960	301950	308960	301951	301940	302916	302916	302916	301984 (LHD)* 301985 (RHD)* 301978** 301997**	VW Exclusive
Tents	QuickFit	307060												
	Residence G3	Side	310205			310205				310218			310219	301560
		Front	310209	310211	310212	310208	310206	310210	310211	310212	310208	310210		
	Panorama New	307089	307090	307091	310220	310221	310222	310225	310226					

* Adapter for VW T5/T6

**Adapter for Mercedes Benz Vito/V-class

Awning Tents - User Manual

All user manuals are available on our website: www.thule.com

> Go to the product page

> Go to "Downloads"

Awning Tents - General Instructions

BEFORE THE INSTALLATION

- The installation instructions are delivered with the tent. Please read them carefully.
You can also have a look at our installation videos on www.thule.com
- Make sure all parts are included and check if the delivered tent matches the type, length and mounting height of your awning
- Make sure the vehicle is levelled
- Check if the connections to the vehicle are sufficiently clean. Sand, dust or dirt could cause damage to your vehicle. If you stay for a long period, clean the tent a few times. Apply foil on the vehicle to prevent the connections from scratching the wall
- Check if the channels are clean
- When attaching the positioning pieces in the main housing of the awning, respect the following rules:
 - The surface has to be dry and clean: no dust, no grease !
 - Press well ! Please wait 72 hours before usage !
- To avoid stains, check if there are no trees above the tent that can deposit resin

INSTALLATION

- Open the awning maximum 1 meter before lowering the support legs
- For an easy setup, install the awning tent with 2 people
- Before installing the pegs and pins, close all zippers
- When using pegs and pins, always use a 45° angle when inserting into the ground (see drawing)
- Use pegs and pins depending on the type of soil
- Hammer the peg into the ground before attaching the elastic in order to avoid damaging the elastic

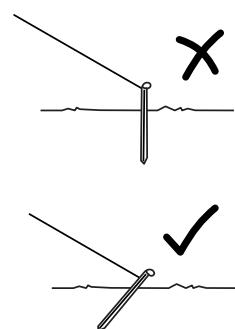

STORAGE

- Make sure not to drag the tent over the ground
- Ensure that there are no hard objects on the windows of the tent during folding, to prevent impressions on them
- Make sure the tent is clean and dry, when being stored for a longer period
- Minimize folding the windows when storing

Awning Tents - Maintenance

- Clean the tent and let dry thoroughly before storage
- Use only water or a dry brush to clean the tent
- Use the Thule PVC Cleaner to clean the PVC fabric of the tent
- Condensation inside the tent is normal. Ventilate the tent adequately

Awning Tents - Important Safety Instructions

- In case of rain, put one awning support leg lower so the water can easily drain off
- When wind reaches 6 Bft. store the tent and close the awning
- Don't place heat sources near the walls or the roof
- Avoid covering the refrigerator grill with the tent
- Use a tension rafter on the awning before tightening the tent completely
- Use a strap kit on the awning after tightening the tent completely

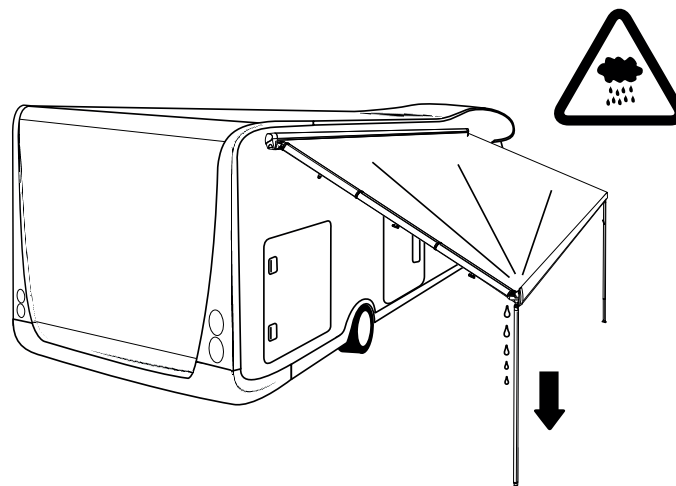
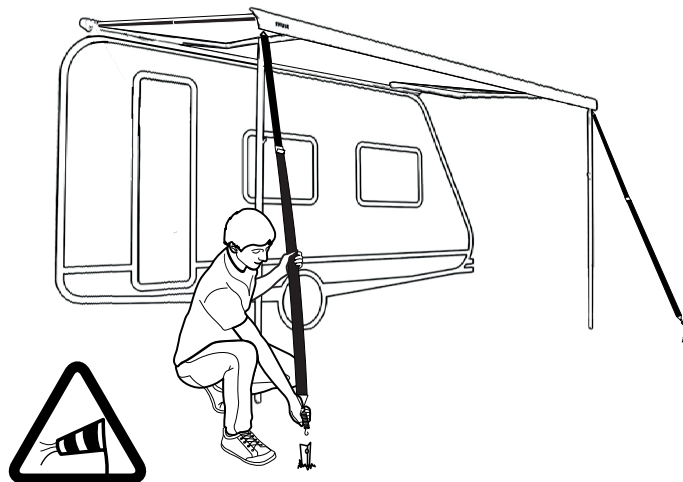

Thule Panorama



INFO

- Length (B) 3.00 m - 6.00 m
- Mounting height (A) 2.30 m - 2.74 m
- Colour Black, silver, white and transparent screen
- Available for Thule Omnistor awnings:
 - 5200, 8000, 9200, 6300, 5003, 6200, 6900
 - 5002*, 5500*, 5800*, 6002, 6802, 6502*combined with a transformation kit: ref. 309623
- Only suitable for vehicles with straight walls
- Special model for Thule Omnistor 6300/6200 on Fiat Ducato H2: mounting height 2.30 m - 2.50 m
- Net weight:
 - 3.00 m Medium: 29.5 kg
 - 6.00 m X-Large: 35.5 kg

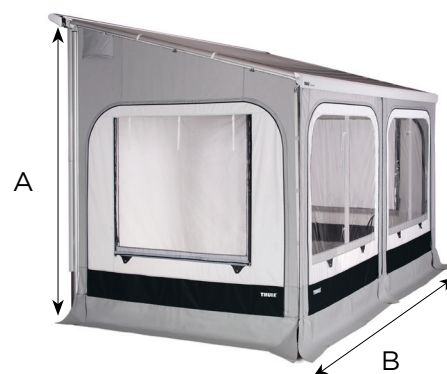

A = distance between bottom of awning's cassette and ground
B = tent length



FEATURES

- Awning tent of high quality material in a timeless design:
 - Special tent fabric: 100% polyester "Airtex"
 - One colour combination fits the various Thule awning fabric finishes
- Easy and user-friendly installation:
 - Each panel has an integrated left and right door
 - Large panoramic windows can be completely removed
 - Side panels are equipped with mosquito mesh which can be closed with transparent windows
 - Permanent aeration on both sides
 - Fully modular system
- High sturdiness and extremely high stability:
 - Clamping profiles to mount the side panels and connect them with the awning fabric for perfect roof sealing
 - Optimal closing due to zipper connecting the front and side panels of the tent
 - A double rubber flap attached to the mast profile ensures full sealing with the vehicle wall
 - A diagonal support between the mast and the clamping profile provides extra sturdiness
- Content:
 - Tent + mounting profiles + connection pieces to the awning
 - Windslip: prevents the wind from entering through the gap below the vehicle
 - Pegs, pins and elastics
 - 1 window tube to open the window (extra tubes can be ordered - 1500600119)
 - Two luxury storage bags from polyester to store the mounting profiles, the tent, pegs, pins, elastics, ...
 - 1 large bag to store the tent: 20 x 30 x 120 cm
 - 1 small bag to store the profiles: 20 x 20 x 130 cm
 - Manual

ACCESSORIES

- Thule Curtains
- Thule Mosquito - Panorama
- Thule Wheelcover
- Thule Hold Down Side Strap Kit
- Thule Tension Rafter G2
- Thule 3rd Support Leg

MODULARITY



FRONT PANEL DESIGN

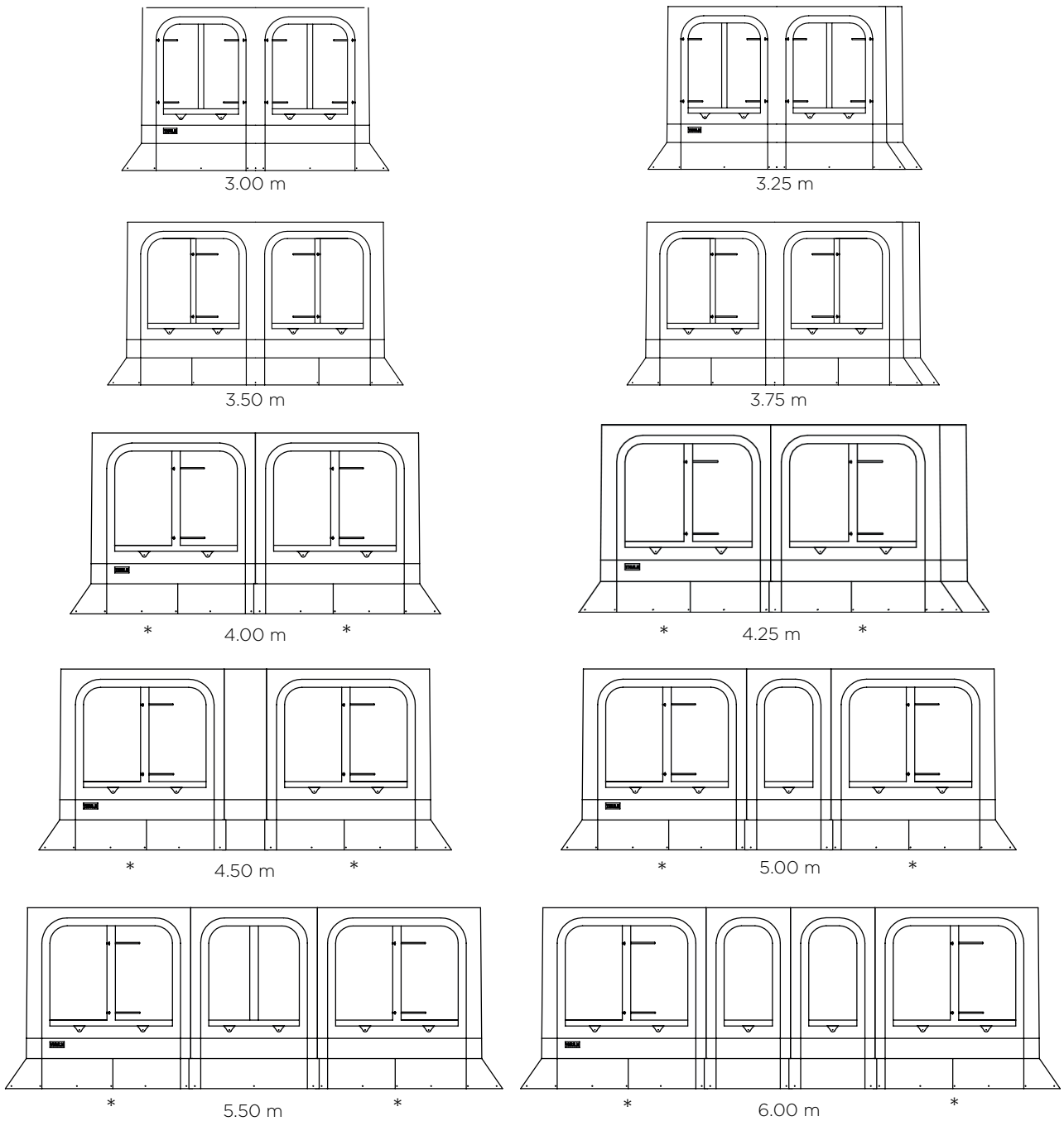

*Front panels replaceable by a mosquito mesh

THULE PANORAMA - DIMENSIONS		
A - MOUNTING HEIGHT		H
Medium	2.30 m - 2.44 m	± 45 cm
Large	2.45 m - 2.59 m	± 60 cm
X-Large	2.60 m - 2.74 m	± 75 cm
Ducato	2.30 m - 2.50 m	± 45 cm

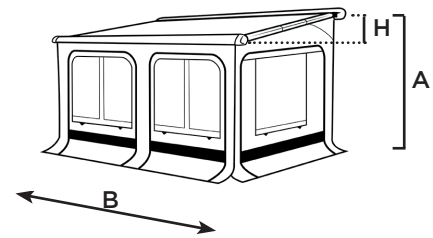

THULE PANORAMA										
AWNING TYPE	A - MOUNTING HEIGHT		LENGTH (B)							
			3.00 m	3.25 m	3.50 m	3.75 m	4.00 m	4.25 m	4.50 m	5.00 m
5200 / 5003	Medium	2.30 m - 2.44 m	301300	-	301301	-	301302	-	301303	301304
	Large	2.45 m - 2.59 m	301305	-	301306	-	301307	-	301308	301309
	X-Large	2.60 m - 2.74 m	-	-	-	-	301310	-	301311	301312
6300	Medium	2.30 m - 2.44 m	306828	306829	306830	306831	306832	308990	306833	301340
	Large	2.45 m - 2.59 m	306834	306835	306836	306837	306838	308991	306839	301341
6002	X-Large	2.60 m - 2.74 m	-	-	-	-	307087	308992	307088	301342

*For Thule Omnistor 5002/5500 - Order Thule Panorama tent for TO 5003 in combination with transformation kit: 309623

THULE PANORAMA							
AWNING TYPE	A - MOUNTING HEIGHT		LENGTH (B)				
			4.00 m	4.50 m	5.00 m	5.50 m	6.00 m
8000*	Medium	2.30 m - 2.44 m	306818	306819	306820	306821	306822
	Large	2.45 m - 2.59 m	306823	306824	306825	306826	306827
	X-Large	2.60 m - 2.74 m	307092	307093	307094	307095	307096
9200	Medium	2.30 m - 2.44 m	306850	306851	306852	306853	306854
	Large	2.45 m - 2.59 m	306855	306856	306857	306858	306859
	X-Large	2.60 m - 2.74 m	307097	307098	307099	307100	307101

*For Thule Omnistor 5800 - Order Thule Panorama tent for TO 8000 in combination with transformation kit: 309623

THULE PANORAMA - DUCATO H2					
AWNING TYPE	A - MOUNTING HEIGHT		LENGTH (B)		
			3.25 m	3.75 m	4.00 m
6300 6200	2.30 m - 2.50 m		307089	310225	310226

Weight for 3.75 m tent: 22.8 kg

Thule Residence G3



INFO

- Length (B) 3.00 m - 6.00 m
- Mounting height (A) 2.15 m - 3.10 m
- Colour Black, grey and white
- Available for Thule Omnistor awnings:
 - 5200, 8000, 4900, 5102, 9200, 6300, 5003, 6200, 6900, 6002, 4200
 - 5002*, 5500*
- *In combination with a transformation kit: ref. 309623
- Only suitable for vehicles with straight walls
- Special models:
 - for Thule Omnistor 5200 Ducato | Jumper | Boxer H2 with Lift Roof
 - for Thule Omnistor 6300 Ducato | Jumper | Boxer H2
 - for Thule Omnistor 5102 on a Volkswagen T5/T6
 - for Thule Omnistor 6300 (3.25 m) on an Eriba Touring
- Net weight:
 - 3.00 m Medium: 27 kg
 - 6.00 m X-Large: 33.5 kg

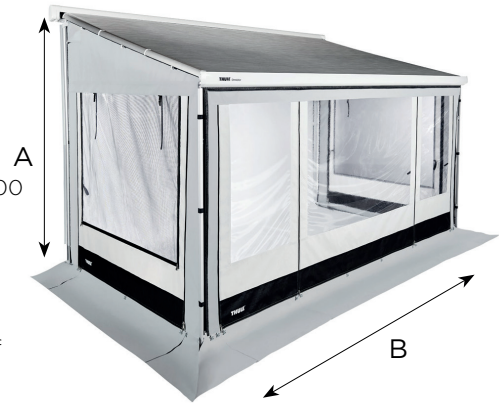

A = distance between bottom of awning's cassette and ground
B = tent length



FEATURES

- Awning tent with a high quality canopy in a timeless design:
 - High quality welded PVC fabric for optimal wind- and watertightness
 - Side panels are equipped with mosquito mesh which can be closed with external transparent blinds
- Easy and user-friendly installation:
 - The side panels are mounted with clamping profiles and the front panel slides into the awning's lead rail
 - Large windows bring in a maximum of light and create a feeling of spaciousness
 - Front panels starting from 3.50 m length have a door opening on both sides and can also be rolled up
 - Front panel can be rolled up completely. The windows in the front cannot be opened
 - Integrated rope attached to the upper side of the front panel to add additional accessories (for example to use a Thule Sun Blocker G2 Front panel)
 - Permanent aeration on both sides
 - Windslip: prevents the wind from entering through the gap below the vehicle
- High sturdiness and extremely high stability:
 - Clamping profiles to mount the side panels and connect them with the awning fabric for perfect roof sealing
 - Optimal closing due to double-shaped profiles (C-profiles) connecting the front and side panels of the tent
 - A double rubber flap attached to the mast profile ensures full sealing with the vehicle wall
 - A diagonal support between the mast and clamping profile provides extra sturdiness
- NOTE: Front and side panels need to be ordered separately
- Content:
 - Side panels: left and right side + mounting profiles + connection pieces to the awning + 2 luxury bags made from polyester fabric to store the mounting profiles, the tent, pegs, pins and elastics, ...
 - Front panel: the complete front panel + pegs and pins + connection profiles (double C-profiles) + windslip + manual

ACCESSORIES

- Thule Curtains
- Thule Wheelcover
- Thule Front Connection Profiles
- Thule Hold Down Side Strap Kit
- Thule Tension Rafter G2
- Thule 3rd Support Leg

FRONT PANEL DESIGN

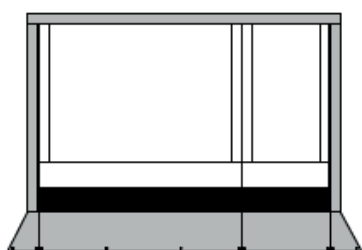

From 3.00 m to 3.25 m

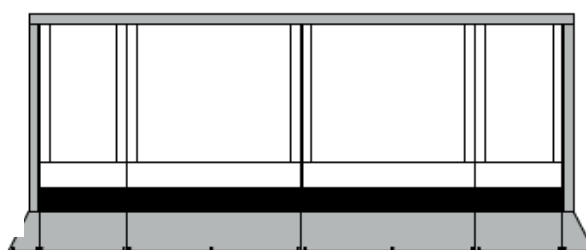

From 5.00 m to 6.00 m

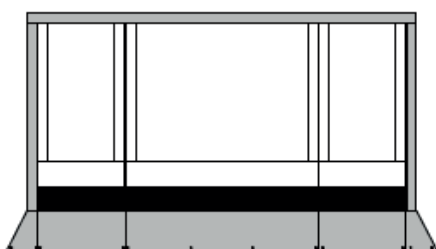

From 3.50 m to 4.50 m

THULE RESIDENCE G3 SIDES - DIMENSIONS			
A - MOUNTING HEIGHT		H	WEIGHT
Small	2.15 m - 2.29 m	± 30 cm	21 kg
Medium	2.30 m - 2.44 m	± 45 cm	22 kg
Large	2.45 m - 2.59 m	± 60 cm	23 kg
X-Large	2.60 m - 2.74 m	± 75 cm	24 kg
XX-Large	2.75 m - 2.89 m	± 75 cm	25 kg
XXX-Large	2.90 m - 3.10 m	± 90 cm	26 kg

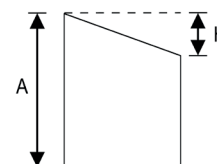

		THULE RESIDENCE G3 - STANDARD SIDES				
		AWNING TYPE				
		5200/5003*/ 4900 / T 4200	8000	6300/6200/ 6002	6900	9200
A - MOUNTING HEIGHT		PROJECTION				
		2.50 m	2.75 m	2.50 m	2.75 m	3.00 m
S	2.15 m - 2.29 m	301500	301513	301520	-	-
M	2.30 m - 2.44 m	301501	301514	301521	301530	301535
L	2.45 m - 2.59 m	301502	301515	301522	301531	301536
XL	2.60 m - 2.74 m	301503	301516	301523	301532	301537
XXL	2.75 m - 2.89 m	301504	301517	301524	301533	301538
XXXL	2.90 m - 3.10 m	301505	301518	301525	301534	301539

*For Thule Omnistor 5002/5500 - Order Thule Residence G3 Sides for TO 5003 in combination with transformation kit: 309623

A - MOUNTING HEIGHT		H	THULE RESIDENCE G3 - SPECIAL SIDES IN COMBINATION WITH XXL/XXXL FRONT		WEIGHT	
			AWNING TYPE			
			5200/5003	8000		
			PROJECTION			
			2.50 m	2.75 m		
M	2.30 m - 2.44 m	30 cm	301506	-	22 kg	
L	2.45 m - 2.59 m	45 cm	301507	301519	23 kg	

THULE RESIDENCE G3 FRONT - DIMENSIONS			
	A - MOUNTING HEIGHT	HEIGHT	WEIGHT
S / M / L / XL	2.15 m - 2.74 m	2.30 m	5.5 kg - 14.4 kg
XXL / XXXL	2.75 m - 3.10 m	2.45 m	6.5 kg - 15.4 kg

THULE RESIDENCE G3 - FRONT										
LENGTH										
	3.00 m	3.25 m	3.50 m	3.75 m	4.00 m	4.25 m	4.50 m	5.00 m	5.50 m	6.00 m
S / M / L / XL (2.15 m - 2.74 m)	301540	301541	301542	301543	301544	301545	301546	301547	301548	301549
XXL / XXXL (2.75 m - 3.10 m)	301550	301551	301552	301553	301554	301555	301556	301557	301558	301559

THULE RESIDENCE G3 FOR DUCATO JUMPER BOXER									
	A - MOUNTING HEIGHT	SIDE PANELS	FRONT PANEL - LENGTH						
			3.00 m	3.15 m	3.25 m	3.50 m	3.75 m	4.00 m	
DUCATO H2 (LIFT ROOF) TO 5200	2.30 m - 2.50 m	310205	310208	310206	-	310210	310211	310212	
DUCATO H2 TO 6300	2.30 m - 2.50 m	310205	-	-	310209	-	310211	310212	

THULE RESIDENCE G3 FOR FORD TRANSIT H3					
	A - MOUNTING HEIGHT	SIDE PANELS	FRONT PANEL - LENGTH		
			3.00 m	3.50 m	4.00 m
FORD TRANSIT H3	2.30 m - 2.50 m	310218	310208	310210	310212

New

THULE RESIDENCE G3 - VW TRANSPORTER/CALIFORNIA + THULE OMNISTOR 5102	
301560	Thule Residence G3 - 2.60 m x 2.00 m (21 kg)

THULE RESIDENCE G3 - ERIBA TOURING CARAVAN + THULE OMNISTOR 6300 3.25 m	
301593	Thule Residence G3 - 3.25 m x 2.50 m (25 kg)

New

THULE RESIDENCE G3 - VW T5/T6 & MB VITO - T 4200	
310219	Thule Residence G3 - VW T5/T6 & MB Vito - T 4200 (2.60 m)

Thule Veduta



INFO

- Length (B) 4.00 m - 5.00 m
- Mounting height (A) 2.45 m - 2.59 m (Large)
- Colour Black, silver, white
- Available for Thule Omnistor awnings 6300 and 6200
- Only suitable for caravans
- Net weight: 32 kg for 4.00 m Large model

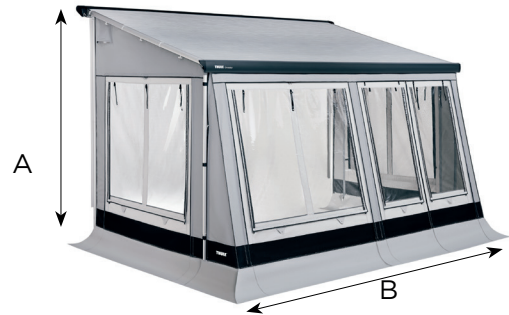

A = distance between bottom of awning's cassette and ground
B = tent length

FEATURES

- Extra space:
 - The sloping front panel offers a large internal living surface and creates a feeling of spaciousness
 - Large panoramic windows
- Awning tent of high quality material in a timeless design:
 - Special tent fabric: 100% polyester "Airtex"
 - One colour combination fits the various Thule awning fabric finishes
- Easy and user-friendly installation:
 - Fully modular system
 - The 4 window panels can be zipped
 - The front panel is easy to install as one complete piece with two or three window panels (see drawing next page)
 - One panel has two integrated door openings and can be placed anywhere you want
 - Integrated rope attached at the upper side of the front panel to add additional accessories (e.g. to use a Thule Sun Blocker G2 front panel)
 - All panels are equipped with mosquito mesh which can be closed with transparent window covers
 - Permanent aeration on both sides
- High sturdiness and extremely high stability:
 - Clamping profiles to mount the side panels and connect them with the awning fabric for a perfect roof sealing
 - Optimal closing due to the zipper connecting the front and side panels of the tent
 - A double rubber flap attached to the mast profile ensures full sealing with the vehicle wall
 - A diagonal support between the mast and the clamping profile provides extra sturdiness
- Content:
 - Tent + mounting profiles + connection pieces to the awning
 - Windslip: prevents the wind from entering through the gap below the vehicle
 - Wheelcover
 - Pegs, pins and elastics
 - Two luxury storage bags from polyester to store the mounting profiles, the tent, pegs, pins, elastics, ...
 - 1 large bag to store the tent: 20 x 30 x 120 cm
 - 1 small bag to store the profiles: 20 x 20 x 130 cm
 - Manual

ACCESSORIES

- Thule Curtains
- Thule Hold Down Side Strap Kit
- Thule Tension Rafter G2



MODULARITY



FRONT PANEL DESIGN

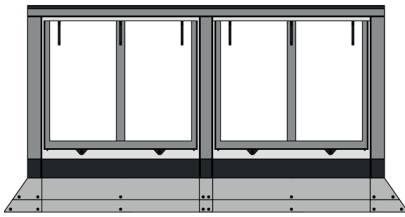

4.00 m



4.25 m

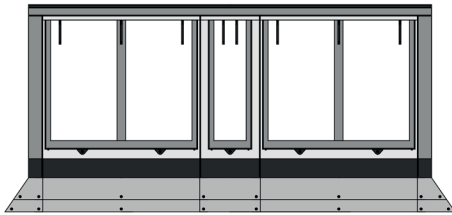

4.50 m

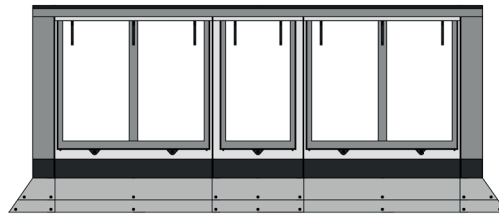

5.00 m

THULE VEDUTA					
AWNING TYPE	MODEL	A - MOUNTING HEIGHT	H	WEIGHT	SKU NO
6300 6200	4.00 m Large	2.45 m - 2.59 m	60 cm	32 kg	301350
6300 6200	4.25 m Large			32.5 kg	301351
6300 6200	4.50 m Large			33 kg	301352
6300 6200	5.00 m Large			34 kg	301353

Thule QuickFit



INFO

- Length (B) 2.60 m (for min. 3.00 m awning length)
3.10 m (for min. 3.50 m awning length)
3.60 m (for min. 4.00 m awning length)
3.00 m for Ducato H2 (for min. 3.25 m awning length)
- Mounting height (A) 3 sizes: between 2.25 m - 2.84 m
1 special mounting height for Ducato H2: 2.30 m - 2.50 m*
- Tent projection (C) 2.25 m (for all awnings with projection 2.50 m)*
* For awnings with a larger projection, use the Thule Projection Kit: 307052
- Colour Black, grey, white
- Available for Thule Omnistor awnings:
- 5200, 8000*, 4900, 9200*, 6300, 1200**, 5003, 6200, 6900*, 6002, 6802*, 6502, 5002, 5500, 5800, 4200
* In combination with the Thule Projection Kit: 307052
** Not suitable for 5.00 m and 5.50 m awnings
- Available for various awning brands:
- Awning with channel lead rail diameter 7 mm: connection pieces included
- Awning with channel lead rail diameter 5 mm (Fiamma) - use optional kit: 307061
- A caravan rail should be present on the vehicle to install the tent, if not: see Tent Accessories - Installation Kits
- In situations where the support legs touch the windslip, sparepart is optional: 1500602794
- Not for vehicles with curved walls
- Special model for Thule Omnistor 6300/6200 on a Ducato H2 (also < 2007) all lengths:
3.25 m - 3.50 m - 3.75 m - 4.00 m
- Net weight:
- 2.60 m Medium: 15.7 kg
- 3.60 m X-Large: 18.4 kg

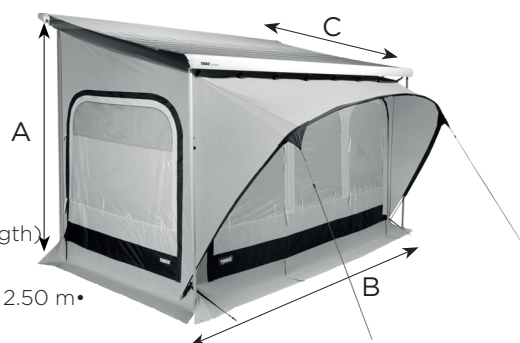

A = Distance between tent rail and the ground
B = Tent length
C = Tent projection



FEATURES

- Awning tent with a high quality canopy:
 - Lightweight tent fabric: strong Ripstop polyester, polyurethane coated (5000 mm) for rain protection
 - One colour combination fits the various Thule awning fabric finishes
- Fast and easy setup (see Tent Accessories - Installation Kits):
 - Tent is in one piece and doesn't need additional fixation profiles
 - Fits caravans with a roof-mounted awning: tent slides in the original caravan rail
 - Fits a Ducato H2 van, only with a TO 6300/6200 awning: special model in combination with the optional rail: Thule Awning Fixation Kit TO 6300/6200/9200 - 307050
 - Fits motorhomes with a TO 6300/6200/9200 roof-mounted awning in combination with the optional Thule Awning Fixation Kit TO 6300/6200/9200 - 307050
 - On RV's with all wall-mounted awnings in an optional rail: Thule Universal Tent Fixation Kit - 307205/307206, or for Thule Omnistor 5200 with the Thule Tent LED Mounting Rail TO 5200

- Modularity:
 - Front panel with integrated left and right door opening
 - All panels can be completely removed
 - Large windows
 - Integrated curtains which can be closed with a zipper
 - Side windows are equipped with mosquito mesh and can be closed with a transparent window
 - Double ceiling created by suspending the tent below the awning fabric ensures a better ventilation and insulation
 - Two permanent ventilation openings allow a perfect air circulation when the tent is closed
 - Hook at the centre of the roof to attach a lamp or other accessories - can only be used with a rafter
 - The front canopy is installed with flexible arch tubes to provide additional shade
- Content:
 - Complete tent with tent poles for the canopy + windslip and wheelcover + connection pieces to the awning + pegs, pins and elastics + manual
 - Storage bag: 35 x 35 x 70 cm

ACCESSORIES

- Thule Universal Tent Fixation Kit
- Thule Awning Fixation Kit TO 6300/6200/9200
- Thule Awning Fixation Kit TO 1200
- Thule Awning Fixation Kit Fiamma
- Thule Tent LED Mounting Rail TO 5200
- Thule Tent LED Mounting Rail TO 6300/6200
- Thule Mosquito for QuickFit
- Thule Hold Down Side Strap Kit
- Thule Side Tensioning Kit
- Thule Projection Kit
- Thule Tension Rafter G2
- Thule Mosquito for QuickFit

MODULARITY

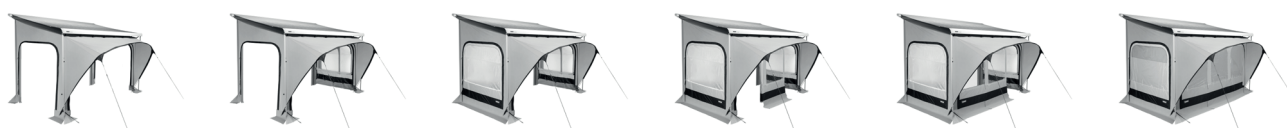

INSTALLATION



THULE QUICKFIT				
MODEL	A - MOUNTING HEIGHT	MIN. AWNING LENGTH	WEIGHT	SKU NO
2.60 m Medium	2.25 m - 2.44 m	3.00 m	15.7 kg	307056
3.10 m Medium		3.50 m	16.7 kg	309921
3.60 m Medium		4.00 m	17.7 kg	307058
2.60 m Large	2.45 m - 2.64 m	3.00 m	16.1 kg	307057
3.10 m Large		3.50 m	17.1 kg	309922
3.60 m Large		4.00 m	18.1 kg	307059
2.60 m X-Large	2.65 m - 2.84 m	3.00 m	16.4 kg	309920
3.10 m X-Large		3.50 m	17.4 kg	309923
3.60 m X-Large		4.00 m	18.4 kg	309924
3.00 m Ducato	2.30 m - 2.50 m	3.25 m	16.4 kg	307060

