

Awning Tents

GENERAL INFORMATION	
Awning Tents - Fit Guide	90
Awning Tents - User Manual	91
Awning Tents - General Instructions	91
Awning Tents - Maintenance	92
Awning Tents - Important Safety Instructions	92

AWNING TENTS	
 Thule Veduta	93
Thule Panorama	95
Thule Residence G3	99
Thule QuickFit	103

Awning Tents - Fit Guide

New

	Thule Veduta	Thule Panorama	Thule Residence G3	Thule QuickFit
Stay	Long stay	Long stay	Long stay	Short stay
INSTALLATION				
Motorhome		•	•	•
Caravan	•	•	•	•
Van		• Ducato H2		• Ducato H2
Minivan			• VW T5/T6 + TO 5102	
FITS				
Awnings	Thule Omnistor 6300 - 6200	Thule Omnistor 5200 - 8000 9200 - 6300 5003 - 5002 5500 - 6200 6002	Thule Omnistor 5200 - 8000 4900 - 5102 9200 - 6300 5003 - 5002 5500 - 6200 6900 - 6002	Thule Omnistor 5200 - 8000 4900 - 9200 6300 - 1200 5003 - 5002 5500 - 6200 6900 - 6002 + other brands
Awning lengths	4.00 m - 5.00 m	3.00 m - 6.00 m	3.00 m - 6.00 m	3.00 m - 6.00 m
Mounting height	2.45 - 2.59 m	2.30 m - 2.74 m	2.15 m - 3.10 m	2.25 m - 2.84 m
Vehicle wall	Straight wall	Straight wall	Straight wall	Straight wall
SPECIFICATIONS				
Maximum tent length	5.00 m	6.00 m	6.00 m	3.60 m
Fabric	AIRTEX® Fabric	AIRTEX® Fabric	PVC Fabric	RIPSTOP Fabric
Curtains	Optional	Optional	Optional	Included
Windslip	Included	Included	Included (with front panel)	Included
Wheelcover	Included	Optional (included for Ducato H2)	Optional	Included
Storage bag	2 Luxury bags	2 Luxury bags	2 Luxury bags (included with side panels)	Sport bag

Awning Tents - User Manual

All user manuals are available on our website: www.thule.com

- > Go to the product page
- > Go to "Downloads"

Awning Tents - General Instructions

BEFORE THE INSTALLATION

- The installation instructions are delivered with the tent. Please read them carefully
- Make sure alle parts are included and check if the delivered tent matches the type, length and mounting height of your awning
- Make sure the vehicle is levelled
- Check if the connections to the vehicle are sufficiently clean. Sand, dust or dirt could cause damage to your vehicle. If you stay for a long period, clean the tent a few times. Apply foil on the vehicle to prevent the connections from scratching the wall
- Check if the channels are clean
- When attaching the positioning pieces in the main housing of the awning, respect the following rules:
 - The surface has to be dry and clean: no dust, no grease !
 - Press well ! Please wait 72 hours before usage !
- To avoid stains, check if there are no trees above the tent that can deposit resin

INSTALLATION

- Open the awning maximum 1 meter before lowering the support legs
- For an easy setup, install the awning tent with 2 people
- Before installing the pegs and pins, close all zippers
- When using pegs and pins, always use a 45° angle when inserting into the ground (see drawing)
- Use pegs and pins depending on the type of soil
- Hammer the peg into the ground before attaching the elastic in order to avoid damaging the elastic

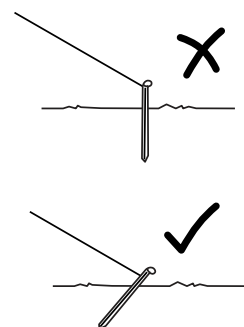

STORAGE

- Make sure not to drag the tent over the ground
- Ensure that there are no hard objects on the windows of the tent during folding, to prevent impressions on them
- Make sure the tent is clean and ddry, when being stored for a longer period
- Minimize folding the windows when storing

Awning Tents - Maintenance

- Clean the tent and let dry thoroughly before storage
- Use only water or a dry brush to clean the tent
- Use the Thule PVC Cleaner to clean the PVC fabric of the tent
- Condensation inside the tent is normal. Ventilate the tent adequately

Awning Tents - Important Safety Instructions

- In case of rain, put one awning support leg lower so the water can easily drain off
- When wind reaches 6 Bft. store the tent and close the awning
- Don't place heat sources near the walls or the roof
- Avoid covering the refrigerator grill with the tent
- Use a tension rafter on the awning before tightening the tent completely
- Use a strap kit on the awning after tightening the tent completely

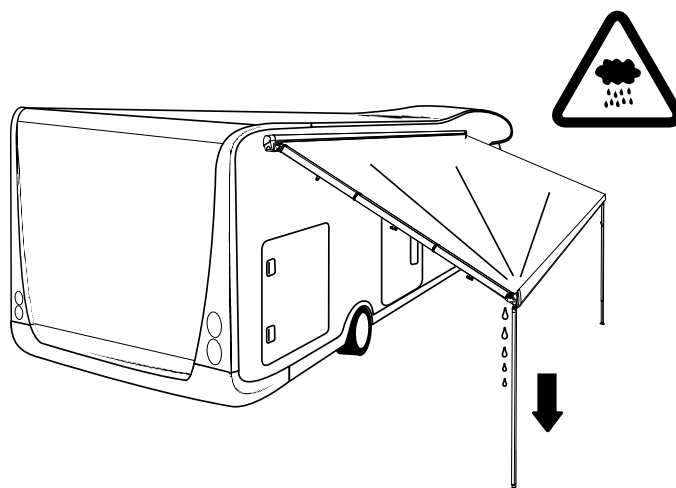
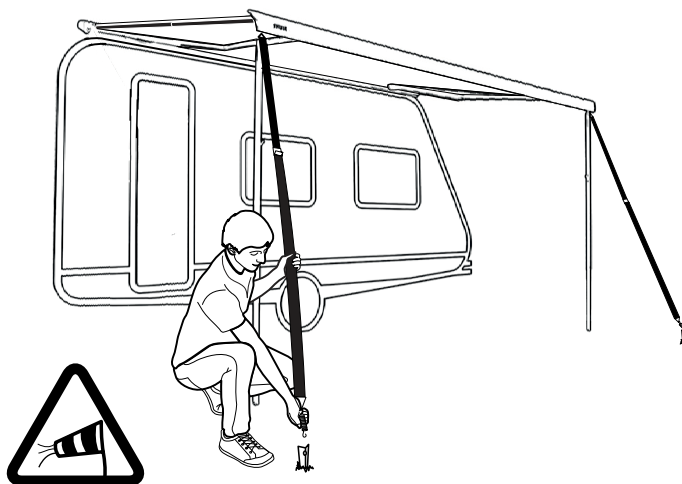

Thule Veduta

Awning tent especially designed for caravans



Awning Tents

INFO

- Length (B) 4.00 m - 5.00 m
- Mounting height (A) 2.45 m - 2.59 m (Large)
- Colour Black, silver, white
- Available for Thule Omnistor awnings:
 - 6300, 6200
- Only suitable for caravans
- Net weight:
 - 4.00 m Large: 32 kg

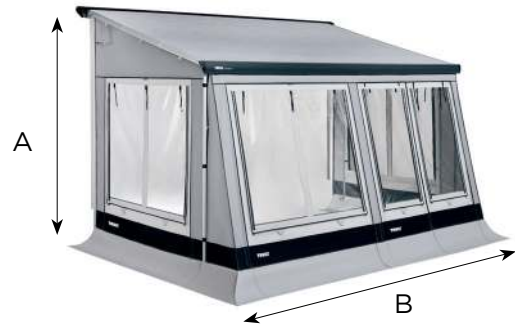

A = distance between bottom of awning's cassette and ground
B = tent length

FEATURES

- Awning tent of high quality material in a timeless design:
 - Special tent fabric: 100% polyester "Airtex"
 - One colour combination fits the various Thule awning fabric finishes
- Easy and user-friendly installation:
 - Fully modular system
 - The 4 window panels can be zipped
 - The sloping front panel offers a large internal living surface and creates a feeling of spaciousness
 - The front panel is easy to install as one complete piece with two or three window panels
 - One panel has two integrated door openings and can be placed anywhere you want
 - Integrated rope attached at the upper side of the front panel to add additional accessories (for example to use a Thule Sun Blocker G2 Front panel)
 - All panels are equipped with mosquito mesh which can be closed with transparent window covers
 - Large panoramic windows
 - Permanent aeration on both sides
- High sturdiness and extremely high stability:
 - Clamping profiles to mount the side panels and connect them with the awning fabric for a perfect roof sealing
 - Optimal closing due to the zipper connecting the front and side panels of the tent
 - A double rubber flap attached to the mast profile ensures full sealing with the vehicle wall
 - A diagonal support between the mast and the clamping profile provides extra sturdiness
- Content:
 - Tent + mounting profiles + connection pieces to the awning
 - Windslip: prevents the wind from entering through the gap below the vehicle
 - Wheelcover
 - Pegs, pins and elastics
 - Two luxury storage bags from polyester to store the mounting profiles, the tent, pegs, pins, elastics, ...
 - 1 large bag to store the tent: 20 x 30 x 120 cm
 - 1 small bag to store the profiles: 20 x 20 x 130 cm
 - Manual



ACCESSORIES

- Thule Curtains
- Thule Hold Down Side Strap Kit
- Thule Tension Rafter G2

MODULARITY



FRONT PANEL DESIGN



4.00 m



4.25 m



4.50 m



5.00 m

THULE VEDUTA					
AWNING TYPE	MODEL	A - MOUNTING HEIGHT	H	WEIGHT	SKU NO
TO 6300 6200	4.00 m Large	2.45 m - 2.59 m	60 cm	32 kg	301350
TO 6300 6200	4.25 m Large			32.5 kg	301351
TO 6300 6200	4.50 m Large			33 kg	301352
TO 6300 6200	5.00 m Large			34 kg	301353

Thule Panorama

Awning tent with high living comfort and stunning view



INFO

- Length (B) 3.00 m - 6.00 m
- Mounting height (A) 2.30 m - 2.74 m
- Colour Black, silver, white and transparent screen
- Available for Thule Omnistor awnings:
 - 5200, 8000, 9200, 6300, 5003, 6200, 6900
 - 5002*, 5500*, 5800*, 6002, 6802, 6502
 - *combined with a transformation kit: ref. 309623
- Only suitable for vehicles with straight walls
- Special model for Thule Omnistor 6300/6200 on Fiat Ducato H2: mounting height 2.30 m - 2.50 m
- Net weight:
 - 3.00 m Medium: 29.5 kg
 - 6.00 m X-Large: 35.5 kg

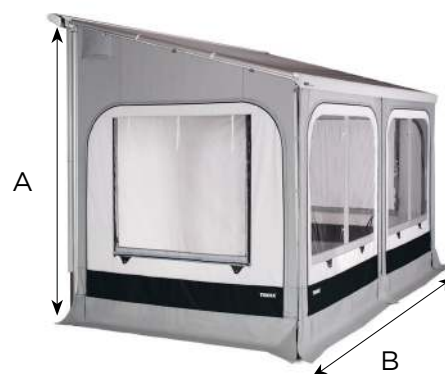

A = distance between bottom of awning's cassette and ground
B = tent length



FEATURES

- Awning tent of high quality material in a timeless design:
 - Special tent fabric: 100% polyester "Airtex"
 - One colour combination fits the various Thule awning fabric finishes
- Easy and user-friendly installation:
 - Each panel has an integrated left and right door
 - Large panoramic windows can be completely removed
 - Side panels are equipped with mosquito mesh which can be closed with transparent windows
 - Permanent aeration on both sides
 - Fully modular system
- High sturdiness and extremely high stability:
 - Clamping profiles to mount the side panels and connect them with the awning fabric for perfect roof sealing
 - Optimal closing due to zipper connecting the front and side panels of the tent
 - A double rubber flap attached to the mast profile ensures full sealing with the vehicle wall
 - A diagonal support between the mast and the clamping profile provides extra sturdiness
- Content:
 - Tent + mounting profiles + connection pieces to the awning
 - Windslip: prevents the wind from entering through the gap below the vehicle
 - Pegs, pins and elastics
 - 1 window tube to open the window (extra tubes can be ordered - 1500600119)
 - Two luxury storage bags from polyester to store the mounting profiles, the tent, pegs, pins, elastics, ...
 - 1 large bag to store the tent: 20 x 30 x 120 cm
 - 1 small bag to store the profiles: 20 x 20 x 130 cm
 - Manual

ACCESSORIES

- Thule Curtains
- Thule Mosquito - Panorama
- Thule Wheelcover
- Thule Hold Down Side Strap Kit
- Thule Tension Rafter G2
- Thule 3rd Support Leg

MODULARITY



FRONT PANEL DESIGN

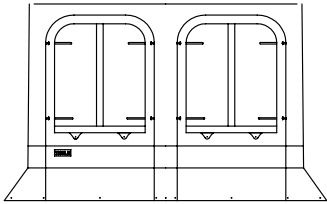

3.00 m

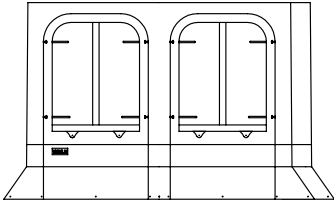

3.25 m

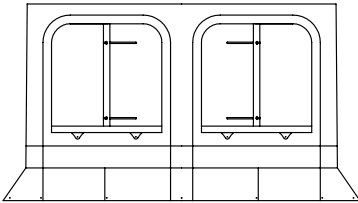

3.50 m

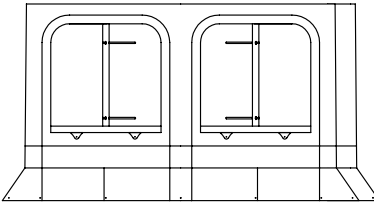

3.75 m

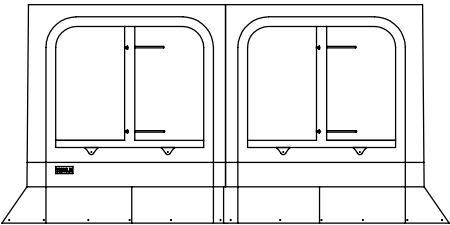

* 4.00 m *

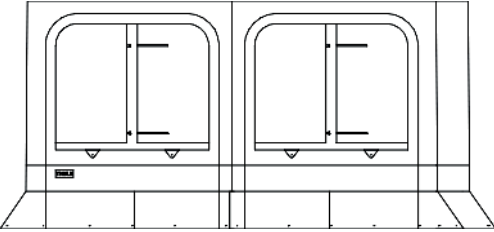

* 4.25 m *

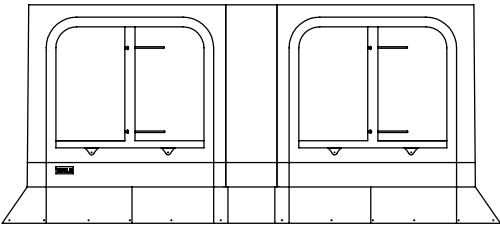

* 4.50 m *

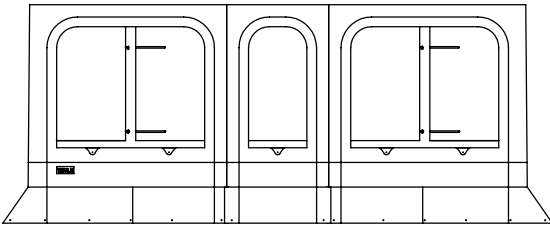

* 5.00 m *

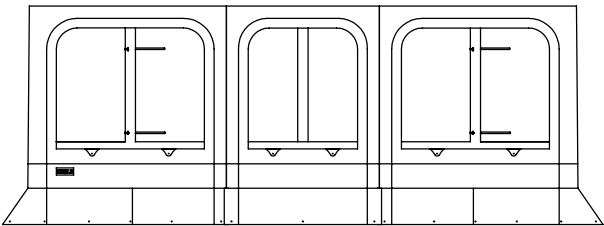

* 5.50 m *

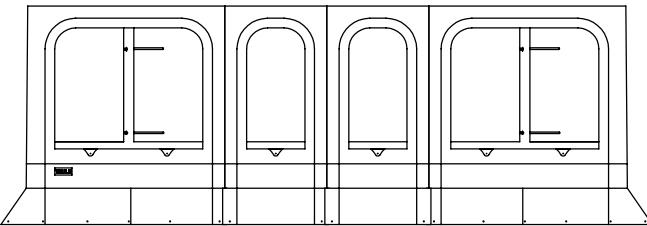

* 6.00 m *

***Front panels replaceable by a mosquito mesh**

THULE PANORAMA - DIMENSIONS		
A - MOUNTING HEIGHT		H
Medium	2.30 m - 2.44 m	± 45 cm
Large	2.45 m - 2.59 m	± 60 cm
X-Large	2.60 m - 2.74 m	± 75 cm
Ducato	2.30 m - 2.50 m	± 45 cm

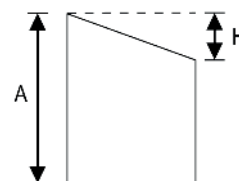

THULE PANORAMA										
AWNING TYPE	A - MOUNTING HEIGHT		LENGTH (B)							
			3.00 m	3.25 m	3.50 m	3.75 m	4.00 m	4.25 m	4.50 m	5.00 m
5200	Medium	2.30 m - 2.44 m	301300	-	301301	-	301302	-	301303	301304
	Large	2.45 m - 2.59 m	301305	-	301306	-	301307	-	301308	301309
	X-Large	2.60 m - 2.74 m	-	-	-	-	301310	-	301311	301312
5003*	Medium	2.30 m - 2.44 m	306810	-	306811	-	306812	-	306813	
	Large	2.45 m - 2.59 m	306814	-	306815	-	306816	-	306817	
	X-Large	2.60 m - 2.74 m	-	-	-	-	307085	-	307086	
6300	Medium	2.30 m - 2.44 m	306828	306829	306830	306831	306832	308990	306833	301340
6200	Large	2.45 m - 2.59 m	306834	306835	306836	306837	306838	308991	306839	301341
6002	X-Large	2.60 m - 2.74 m	-	-	-	-	307087	308992	307088	301342

*For Thule Omnistor 5002/5500 - Order Thule Panorama tent for TO 5003 in combination with transformation kit: 309623

THULE PANORAMA							
AWNING TYPE	A - MOUNTING HEIGHT		LENGTH (B)				
			4.00 m	4.50 m	5.00 m	5.50 m	6.00 m
6900	Medium	2.30 m - 2.44 m	306840	306841	306842	306843	-
	Large	2.45 m - 2.59 m	306845	306846	306847	306848	-
8000*	Medium	2.30 m - 2.44 m	306818	306819	306820	306821	306822
	Large	2.45 m - 2.59 m	306823	306824	306825	306826	306827
	X-Large	2.60 m - 2.74 m	307092	307093	307094	307095	307096
9200	Medium	2.30 m - 2.44 m	306850	306851	306852	306853	306854
	Large	2.45 m - 2.59 m	306855	306856	306857	306858	306859
	X-Large	2.60 m - 2.74 m	307097	307098	307099	307100	307101

*For Thule Omnistor 5800 - Order Thule Panorama tent for TO 8000 in combination with transformation kit: 309623

THULE PANORAMA - DUCATO H2				
AWNING TYPE	A - MOUNTING HEIGHT	LENGTH (B)		
		3.25 m	3.75 m	4.00 m
6300 6200	2.30 m - 2.50 m	307089	307090	307091

Weight for 3.75 m tent: 22.8 kg

Order Form Thule Panorama

Customer Information

Customer Name:.....

Order Number:

Company Name:.....

Date:

1. What is your awning type?

- Wall-mounted: TO 5200 TO 8000/5800* TO 5003 TO 5002*/5500*
 Roof-mounted: TO 9200 TO 6300/6200 TO 6900/6802 TO 6002/6502

2. What is your awning length?

- 3.00 m 3.25 m 3.50 m 3.75 m
 4.00 m 4.25 m 4.50 m
 5.00 m 5.50 m
 6.00 m

3. What is your mounting height?

Mounting height (A) = measured from ground to bottom of awning cassette
 Awning incline (H)

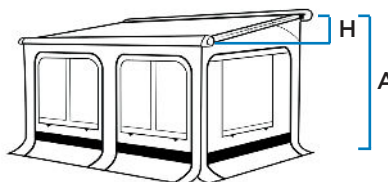

- | | A | H |
|-----------------------------------|-----------------|-------|
| <input type="radio"/> M | 2.30 m - 2.44 m | 45 cm |
| <input type="radio"/> L | 2.45 m - 2.59 m | 60 cm |
| <input type="radio"/> XL | 2.60 m - 2.74 m | 75 cm |
| <input type="radio"/> Ducato..... | 2.30 m - 2.50 m | 45 cm |

NOTE: Before ordering, put the awning with prescribed awning inclination to control opening of the entrance door

Accessories

- | | |
|-----------------------------------------------------------------------|--------|
| <input type="radio"/> Thule Curtains Set 1: 3.00 m - 4.50 m | 301563 |
| <input type="radio"/> Thule Curtains Set 3: 5.00 m - 6.00 m | 301565 |
| <input type="radio"/> Thule Mosquito Panorama - Side Panel | 309930 |
| <input type="radio"/> Thule Mosquito Panorama - Front Panel | 309931 |
| <input type="radio"/> Thule Hold Down Side Strap Kit | 307916 |
| <input type="radio"/> Thule Wheelcover | 307397 |
| <input type="radio"/> *Thule Transformation Kit for TO 5002/5500/5800 | 309623 |

Thule Residence G3

A real living room in the outdoors



INFO

- Length (B) 3.00 m - 6.00 m
- Mounting height (A) 2.15 m - 3.10 m
- Colour Black, grey and white
- Available for Thule Omnistor awnings:
 - 5200, 8000, 4900, 5102, 9200, 6300, 5003, 6200, 6900, 6002
 - 5002*, 5500*
- *In combination with a transformation kit: ref. 309623
- Only suitable for vehicles with straight walls
- Special model for Thule Omnistor 5102 on a Volkswagen T5/T6
- Special model for Thule Omnistor 6300 (3.25 m) on an Eriba Touring
- Net weight:
 - 3.00 m Medium: 27 kg
 - 6.00 m X-Large: 33.5 kg

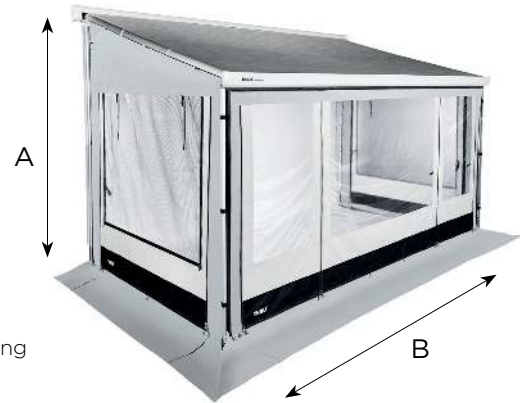

A = distance between bottom of awning's cassette and ground
B = tent length



FEATURES

- Awning tent with a high quality canopy in a timeless design:
 - High quality welded PVC fabric for optimal wind- and watertightness
- Easy and user-friendly installation:
 - The side panels are mounted with clamping profiles and the front panel slides into the awning's lead rail
 - Side panels are equipped with mosquito mesh which can be closed with external transparent blinds
 - Large windows bring in a maximum of light and create a feeling of spaciousness
 - Front panels starting from 3.50 m length have a door opening on both sides and can also be rolled up
 - Front panel can be rolled up completely. The windows in the front cannot be opened
 - Integrated rope attached at the upper side of the front panel to add additional accessories (for example to use a Thule Sun Blocker G2 Front panel)
 - Permanent aeration on both sides
- High sturdiness and extremely high stability:
 - Clamping profiles to mount the side panels and connect them with the awning fabric for perfect roof sealing
 - Optimal closing due to double-shaped profiles (C-profiles) connecting the front and side panels of the tent
 - A double rubber flap attached to the mast profile ensures full sealing with the vehicle wall
 - A diagonal support between the mast and clamping profile provides extra sturdiness
- NOTE: Front and side panels need to be ordered separately
- Content:
 - Side panels: left and right side + mounting profiles + connection pieces to the awning + 2 luxury bags made from polyester fabric to store the mounting profiles, the tent, pegs, pins and elastics, ...
 - Front panel: the complete front panel + pegs and pins + connection profiles (double C-profiles) + windslip + manual

ACCESSORIES

- Thule Curtains
- Thule Wheelcover
- Thule Front Connection Profiles
- Thule Hold Down Side Strap Kit
- Thule Tension Rafter G2
- Thule 3rd Support Leg

FRONT PANEL DESIGN

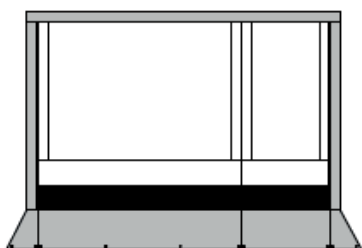

From 3.00 m to 3.25 m

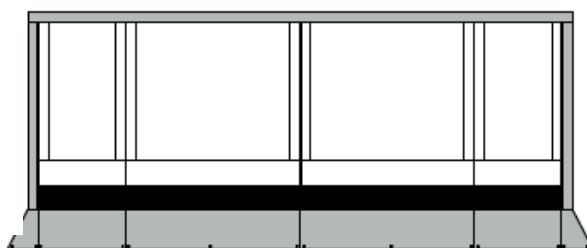

From 5.00 m to 6.00 m

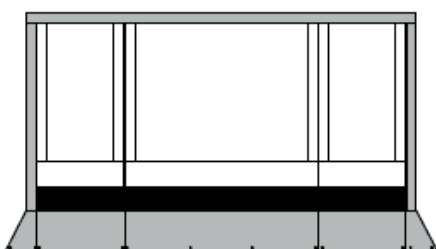

From 3.50 m to 4.50 m

THULE RESIDENCE G3 SIDES - DIMENSIONS			
A - MOUNTING HEIGHT		H	WEIGHT
Small	2.15 m - 2.29 m	± 30 cm	21 kg
Medium	2.30 m - 2.44 m	± 45 cm	22 kg
Large	2.45 m - 2.59 m	± 60 cm	23 kg
X-Large	2.60 m - 2.74 m	± 75 cm	24 kg
XX-Large	2.75 m - 2.89 m	± 75 cm	25 kg
XXX-Large	2.90 m - 3.10 m	± 90 cm	26 kg

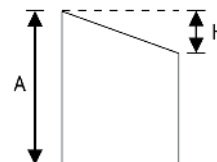

		THULE RESIDENCE G3 - STANDARD SIDES				
		AWNING TYPE				
		5200/5003*/ 4900	8000	6300/6200/ 6002	6900	9200
A - MOUNTING HEIGHT		PROJECTION				
		2.50 m	2.75 m	2.50 m	2.75 m	3.00 m
S	2.15 m - 2.29 m	301500	301513	301520	-	-
M	2.30 m - 2.44 m	301501	301514	301521	301530	301535
L	2.45 m - 2.59 m	301502	301515	301522	301531	301536
XL	2.60 m - 2.74 m	301503	301516	301523	301532	301537
XXL	2.75 m - 2.89 m	301504	301517	301524	301533	301538
XXXL	2.90 m - 3.10 m	301505	301518	301525	301534	301539

*For Thule Omnistor 5002/5500 - Order Thule Residence G3 Sides for TO 5003 in combination with transformation kit: 309623

A - MOUNTING HEIGHT		H	THULE RESIDENCE G3 - SPECIAL SIDES IN COMBINATION WITH XXL/XXXL FRONT		
			AWNING TYPE		WEIGHT
			5200/5003	8000	
			PROJECTION		
2.50 m	2.75 m				
M	2.30 m - 2.44 m	30 cm	301506	-	22 kg
L	2.45 m - 2.59 m	45 cm	301507	301519	23 kg

THULE RESIDENCE G3 FRONT - DIMENSIONS			
	A - MOUNTING HEIGHT	HEIGHT	WEIGHT
S / M / L / XL	2.15 m - 2.74 m	2.30 m	5.5 kg - 14.4 kg
XXL / XXXL	2.75 m - 3.10 m	2.45 m	6.5 kg - 11.8 kg

THULE RESIDENCE G3 - FRONT										
LENGTH										
	3.00 m	3.25 m	3.50 m	3.75 m	4.00 m	4.25 m	4.50 m	5.00 m	5.50 m	6.00 m
S / M / L / XL (2.15 m - 2.74 m)	301540	301541	301542	301543	301544	301545	301546	301547	301548	301549

THULE RESIDENCE G3 - FRONT										
LENGTH										
	3.00 m	3.25 m	3.50 m	3.75 m	4.00 m	4.25 m	4.50 m	5.00 m	5.50 m	6.00 m
XXL / XXXL (2.75 m - 3.10 m)	301550	301551	301552	301553	301554	301555	301556	301557	301558	301559

THULE RESIDENCE G3 - VW TRANSPORTER/CALIFORNIA + THULE OMNISTOR 5102	
301560	Thule Residence G3 - 2.60 m x 2.00 m (21 kg)

THULE RESIDENCE G3 - ERIBA TOURING CARAVAN + THULE OMNISTOR 6300 3.25 m	
301593	Thule Residence G3 - 3.25 m x 2.50 m (25 kg)

Order Form Thule Residence G3

Customer Information

Customer Name:.....

Order Number:

Company Name:.....

Date:

1. What is your awning type?

Wall-mounted: TO 5200/5003/4900 TO 8000 TO 5002*/5500*

Roof-mounted: TO 6300/6200/6002 TO 9200 TO 6900

2. What is your awning length?

- | | | | |
|------------------------------|------------------------------|------------------------------|------------------------------|
| <input type="radio"/> 3.00 m | <input type="radio"/> 3.25 m | <input type="radio"/> 3.50 m | <input type="radio"/> 3.75 m |
| <input type="radio"/> 4.00 m | <input type="radio"/> 4.25 m | <input type="radio"/> 4.50 m | |
| <input type="radio"/> 5.00 m | <input type="radio"/> 5.50 m | | |
| <input type="radio"/> 6.00 m | | | |

3. What is your mounting height?

Mounting height (A) = measured from ground to bottom of awning cassette
 Awning incline (H)

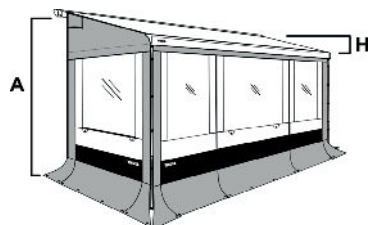

	A	H
<input type="radio"/> S.....	2.15 m - 2.29 m	30 cm
<input type="radio"/> M.....	2.30 m - 2.44 m	45 cm
<input type="radio"/> L.....	2.45 m - 2.59 m	60 cm
<input type="radio"/> XL.....	2.60 m - 2.74 m	75cm
<input type="radio"/> XXL.....	2.75 m - 2.89 m	75 cm
<input type="radio"/> XXXL.....	2.90 m - 3.10 m	90 cm

In combination with Front XXL/XXXL

<input type="radio"/> Special M.....	2.30 m - 2.44 m	30 cm
<input type="radio"/> Special L.....	2.45 m - 2.59 m	45 cm

NOTE: Before ordering, put awning with prescribed awning inclination to control opening of entrance door

Side Panel Set

Order a side panel set (mounting profiles and 2 luxury bags included): Ref.

Front Panel

Order a front panel (double C-profiles, windslip, pegs and pins included): Ref.

Accessories

- | | |
|------------------------------------------------------------------|--------|
| <input type="radio"/> Thule Curtains Set 1: 3.00 m - 4.00 m | 301563 |
| <input type="radio"/> Thule Curtains Set 2: 4.25 m - 5.00 m | 301564 |
| <input type="radio"/> Thule Curtains Set 3: 5.50 m - 6.00 m | 301565 |
| <input type="radio"/> Thule Hold Down Side Strap Kit | 307916 |
| <input type="radio"/> Thule Front Connection Profiles (6x 1 m) | 301567 |
| <input type="radio"/> Thule Wheelcover | 307397 |
| <input type="radio"/> *Thule Transformation Kit for TO 5002/5500 | 309623 |

Thule QuickFit



Universal fitting on awnings with projections starting from 2.50 m

A = Distance between tent rail and the ground
 B = Tent length
 C = Tent projection

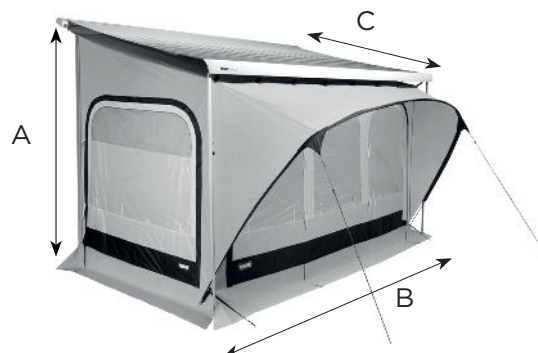

INFO

- Length (B)
 - 2.60 m (for min. 3.00 m awning length)
 - 3.10 m (for min. 3.50 m awning length)
 - 3.60 m (for min. 4.00 m awning length)
 - 3.00 m for Ducato H2 (for min. 3.25 m awning length)
- Mounting height (A)
 - 3 sizes: between 2.25 m - 2.84 m
 - 1 special mounting height for Ducato H2: 2.30 m - 2.50 m
- Tent projection (C)
 - 2.25 m (for all awnings with projection 2.50 m)*
 - * For awnings with a larger projection, use the Thule Projection Kit: 307052
- Colour
 - Black, grey, white
- Available for Thule Omnistor awnings:
 - 5200, 8000*, 4900, 9200*, 6300, 1200**, 5003, 6200, 6900*, 6002, 6802*, 6502, 5002, 5500, 5800
 - * In combination with the Thule Projection Kit: 307052
 - ** Not suitable for 5.00 m and 5.50 m awnings
- Available for various awning brands:
 - Awning with channel lead rail diameter 7 mm: connection pieces included
 - Awning with channel lead rail diameter 5 mm (Fiamma) - use optional kit: 307061
- A caravan rail should be present on the vehicle to install the tent, if not: see Tent Accessories - Installation Kits
- In situations where the support legs touch the windslip, sparepart is optional: 1500602794
- Not for vehicles with curved walls
- Special model for Thule Omnistor 6300/6200 on a Ducato H2 (also <2007) all lengths:
 - 3.25 m - 3.50 m - 3.75 m - 4.00 m
- Net weight:
 - 2.60 m Medium: 15.7 kg
 - 3.60 m X-Large: 18.4 kg

FEATURES

- Awning tent with a high quality canopy:
 - Lightweight tent fabric: strong Ripstop polyester, polyurethane coated (5000 mm) for rain protection
 - One colour combination fits the various Thule awning fabric finishes
- Fast and easy setup (see Tent Accessories - Installation Kits):
 - Tent is in one piece and doesn't need additional fixation profiles
 - Fits caravans with a roof-mounted awning: tent slides in the original caravan rail
 - Fits a Ducato H2 van, only with a TO 6300/6200 awning: special model in combination with the optional rail: Thule Awning Fixation Kit TO 6300/6200/9200 - 307050
 - Fits motorhomes with a TO 6300/6200/9200 roof-mounted awning in combination with the optional Thule Awning Fixation Kit TO 6300/6200/9200 - 307050
 - On RV's with all wall-mounted awnings in an optional rail: Thule Universal Tent Fixation Kit - 307205/307206, or for Thule Omnistor 5200 with the Thule Tent LED Mounting Rail TO 5200

- Modularity:
 - Front panel with integrated left and right door opening
 - All panels can be completely removed
 - Large windows
 - Integrated curtains which can be closed with a zipper
 - Side windows are equipped with mosquito mesh and can be closed with a transparent window
 - Double ceiling created by suspending the tent below the awning fabric ensures a better ventilation and insulation
 - Two permanent ventilation openings allow a perfect air circulation when the tent is closed
 - Hook at the centre of the roof to attach a lamp or other accessories - can only be used with a rafter
 - The front canopy is installed with flexible arch tubes to provide additional shade
- Content:
 - Complete tent with tent poles for the canopy + windslip and wheelcover + connection pieces to the awning + pegs, pins and elastics + manual
 - Storage bag: 35 x 35 x 70 cm

ACCESSORIES

- Thule Universal Tent Fixation Kit
- Thule Awning Fixation Kit TO 6300/6200/9200
- Thule Awning Fixation Kit TO 1200
- Thule Awning Fixation Kit Fiamma
- Thule Tent LED Mounting Rail TO 5200
- Thule Tent LED Mounting Rail TO 6300/6200
- Thule Mosquito for QuickFit
- Thule Hold Down Side Strap Kit
- Thule Side Tensioning Kit
- Thule Projection Kit
- Thule Tension Rafter G2
- Thule Mosquito for QuickFit

MODULARITY



INSTALLATION



THULE QUICKFIT				
MODEL	A - MOUNTING HEIGHT	MIN. AWNING LENGTH	WEIGHT	SKU NO
2.60 m Medium	2.25 m - 2.44 m	3.00 m	15.7 kg	307056
3.10 m Medium		3.50 m	16.7 kg	309921
3.60 m Medium		4.00 m	17.7 kg	307058
2.60 m Large	2.45 m - 2.64 m	3.00 m	16.1 kg	307057
3.10 m Large		3.50 m	17.1 kg	309922
3.60 m Large		4.00 m	18.1 kg	307059
2.60 m X-Large	2.65 m - 2.84 m	3.00 m	16.4 kg	309920
3.10 m X-Large		3.50 m	17.4 kg	309923
3.60 m X-Large		4.00 m	18.4 kg	309924
3.00 m Ducato	2.30 m - 2.50 m	3.25 m	16.4 kg	307060